

# Installation and Maintenance Instructions

CONTENTS	Page
<b>SAFETY CONSIDERATIONS</b> .....	1
<b>GENERAL</b> .....	2
<b>DIMENSIONS</b> .....	4
<b>INSTALLATION</b> .....	5
Step 1 — Unpack and Inspect Units .....	5
Step 2 — Position the Unit .....	5
Step 3 — Install Ductwork .....	6
Step 4 — Connect Piping .....	6
Step 5 — Complete Electrical Connections .....	7
Step 6 — Position and Connect Controller .....	7
<b>ACB (Auxiliary Control Board) Interface</b> .....	12
<b>START-UP</b> .....	12
Pre-Start Check .....	12
System Operation Check .....	12
<b>MAINTENANCE</b> .....	12
<b>INDOOR UNIT ADDRESSING</b> .....	12
Wireless Remote Controller (40VM900001) .....	12
Non-Programmable Controller .....	13
Programmable Controller .....	13
<b>TROUBLESHOOTING</b> .....	14
<b>APPENDIX A — DIP SWITCH SETTINGS</b> .....	16
<b>APPENDIX B — NAMEPLATES</b> .....	17
Replacement Parts .....	17
<b>APPENDIX C — FAN CURVES</b> .....	19

## SAFETY CONSIDERATIONS

Improper installation, adjustment, alteration, service, maintenance, or use can cause explosion, fire, electrical shock, or other conditions which, may cause death, personal injury or property damage. The qualified installer or agency must use factory authorized kits or accessories when modifying this product.

Follow all safety codes. Wear safety glasses, protective clothing, and work gloves. Use quenching cloth for brazing operations. Have fire extinguisher available. Read these instructions thoroughly and follow all warnings or cautions included in literature and attached to the unit. Consult local building codes and the current editions of the National Electrical Code (NEC) ANSI/NFPA (American National Standards Institute/National Fire Protection Association) 70. For Canada, refer to the current editions of the Canadian Electrical Code CSA (Canadian Standards Association) C22.1.

Understand the signal words — **DANGER**, **WARNING**, and **CAUTION**. **DANGER** identifies the most serious hazards, which will result in severe personal injury or death. **WARNING** signifies hazards that could result in personal injury or death. **CAUTION** is used to identify unsafe practices, which could result in minor personal injury or product and property damage.

Recognize safety information. This is the safety-alert symbol (⚠). When this symbol is displayed on the unit and in instructions or manuals, be alert for the potential of personal injury. Installing, starting up, and servicing the equipment can be hazardous due to system pressure, electrical components, and equipment location.

**⚠ WARNING**

Electrical shock can cause personal injury and death. Shut off all power to this equipment during installation. There may be more than one disconnect switch. Tag all disconnect locations to alert others not to restore power until work is completed.

**⚠ WARNING**

When installing the equipment in a small space, provide adequate measures to avoid refrigerant concentration exceeding safety limits due to refrigerant leak. In case of refrigerant leak during installation, ventilate the space immediately. Failure to follow this procedure may lead to personal injury.

**⚠ WARNING**

**DO NOT USE TORCH** to remove any component. System contains oil and refrigerant under pressure.

To remove a component, wear protective gloves and goggles and proceed as follows:

- a. Shut off electrical power to unit.
- b. Recover refrigerant to relieve all pressure from system using both high pressure and low pressure ports.
- c. Traces of vapor should be displaced with nitrogen and the work area should be well ventilated. Refrigerant in contact with an open flame can produce toxic gases.
- d. Cut component connection tubing with tubing cutter and remove component from unit. Use a pan to catch any oil that may come out of the lines and as a gage for how much oil to add to the system.
- e. Carefully unsweat remaining tubing stubs when necessary. Oil can ignite when exposed to torch flame.

Failure to follow these procedures may result in personal injury or death.

**CAUTION**

DO NOT re-use compressor oil or any oil that has been exposed to the atmosphere. Dispose of oil per local codes and regulations. DO NOT leave refrigerant system open to air any longer than the actual time required to service the equipment. Seal circuits being serviced and charge with dry nitrogen to prevent oil contamination when timely repairs cannot be completed. Failure to follow these procedures may result in damage to equipment. For information about replacement oil type and viscosity, see the Installation, Start-Up, and Service Instructions for the 38VMAH and 38VMAR outdoor units.

**GENERAL**

The 40VMV vertical AHU (air-handling unit) is equipped with a DC motor. The unit features dual drain spouts so it can be mounted vertically or horizontally, and is ideal for closet applications. Through thermostatic control of operations, conditions can be varied to suit diverse requirements and activities.

The equipment is initially protected under the manufacturer’s standard warranty; however, the warranty is provided under the condition that the steps outlined in this manual for initial inspection, proper installation, regular periodic maintenance, and everyday operation of the unit be followed in detail. This manual should be fully reviewed in advance before initial installation, start-up, and any maintenance. Contact your local sales representative or the factory with any questions BEFORE proceeding.

Table 1 shows components that may or may not be used for a particular installation. Table 2 lists physical data for each unit size. See Fig. 1 for model number nomenclature. Fig. 2 shows unit dimensions.

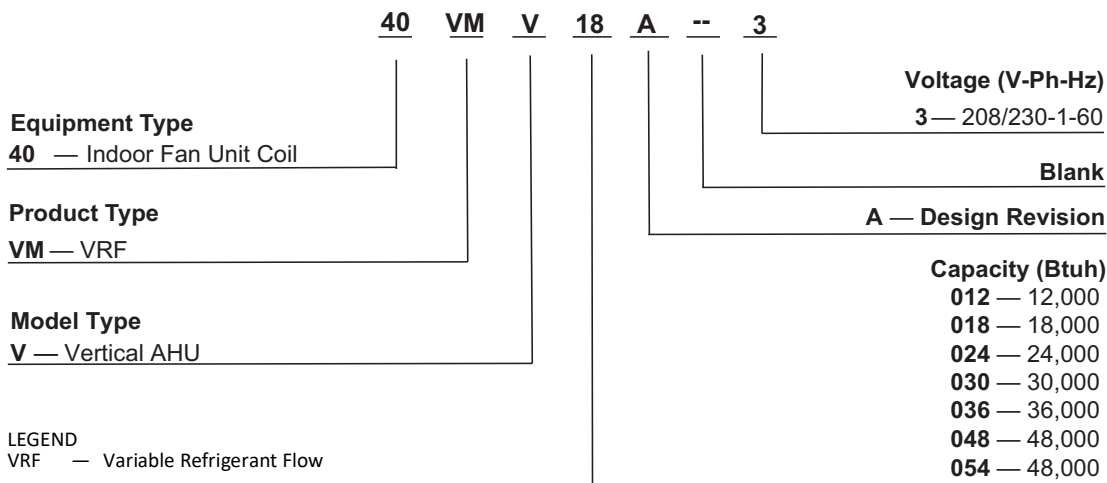

**Fig. 1 —Model Number Nomenclature**  
**Table 1 — Components Shipped With Unit**

NAME	SHAPE	QUANTITY	FUNCTION
Copper pipes		2	Reducer for smaller pipe diameter (only for size 018 unit).
Drain plug		2	Plug for drain pan outlet
Wire grommet		2	For wire routing
Tie rope		3	-----
Screw		4	-----
PQ connection wire		2	To connect the outdoor unit, indoor unit and sub MDC.
Connecting wire		1	For occupancy sensor
No Beep Harness		1	Prevent beeping noise

**LEGEND**  
MDC — Multipoint Distribution Controller

**Table 2 — 40VMV Physical Data**

UNIT 40VMV	012A	018A	024A	030A	036A	048A	054A
POWER SUPPLY (V-Ph-Hz)	208/230-1-60						
COOLING CAPACITY (Btuh)							
Total	12,000	18,000	24,000	30,000	36,000	48,000	53,500
Sensible	9,400	14,000	18,600	22,600	28,300	37,100	41,300
HEATING CAPACITY (Btuh)	13,500	21,000	27,000	34,000	40,000	54,000	60,000
INDOOR FAN MOTOR							
Type	DC Motor						
Input (W)	43	60	100	151	187	355	466
INDOOR COIL							
Number of Rows	2			3			
Fin Spacing (fins/in.)	16				17		
Fin Type	Hydrophilic Aluminum						
Tube Diameter, OD (in.)	0.276						
Tube Type	Inner Groove						
Number of Circuits	4		6		10		
INDOOR AIRFLOW (cfm)							
High	400	600	800	1000	1200	1600	1800
Medium	320	510	680	850	1020	1360	1530
Low	320	420	560	700	840	1120	1260
EXTERNAL STATIC PRESSURE (in. wg)	0.8						
INDOOR UNIT NOISE LEVEL (dBA)							
High	37.6	41.6	46.2	52.2	46.9	53.0	57.1
Medium	34.5	37.1	42.3	48.4	44.1	48.5	52.6
Low	34.5	34.4	37.9	44.4	39.3	43.8	47.9
UNIT							
Unit Dimensions, W x H x D (in.)	19-5/8 x 46-1/2 x 20-5/8				22 x 54-1/2 x 24		
Packing Dimensions, W x H x D (in.)	22-5/8 x 50-5/8 x 25-3/8				24-5/8 x 58-5/8 x 27-3/4		
Net/Gross Weight (lb)*	115/139		119/143		157/183		
FILTER							
Dimensions, L x H x D (lbs.)	18 x 20 x 1				20 x 22 x 1		
Qty	1						
REFRIGERANT TYPE	R-410A						
THROTTLE	EEV						
DESIGN PRESSURE (psig)	580/320						
REFRIGERANT PIPING (in.)							
Liquid Side, OD	1/4						3/8
Gas Side, OD	1/2						5/8
CONNECTING WIRING (AWG)							
Power Wiring	Sized per NEC and local codes based on nameplate electrical data						
Signal Wiring	2-core stranded shielded cable 18 AWG						
CONDENSATE DRAIN PIPE DIAMETER, OD (in.)	3/4 NPT						

**LEGEND**

- AWG — American Wire Gage
- EEV — Electronic Expansion Valve
- NEC — National Electric Code

\*Gross weight includes packaging.

# DIMENSIONS

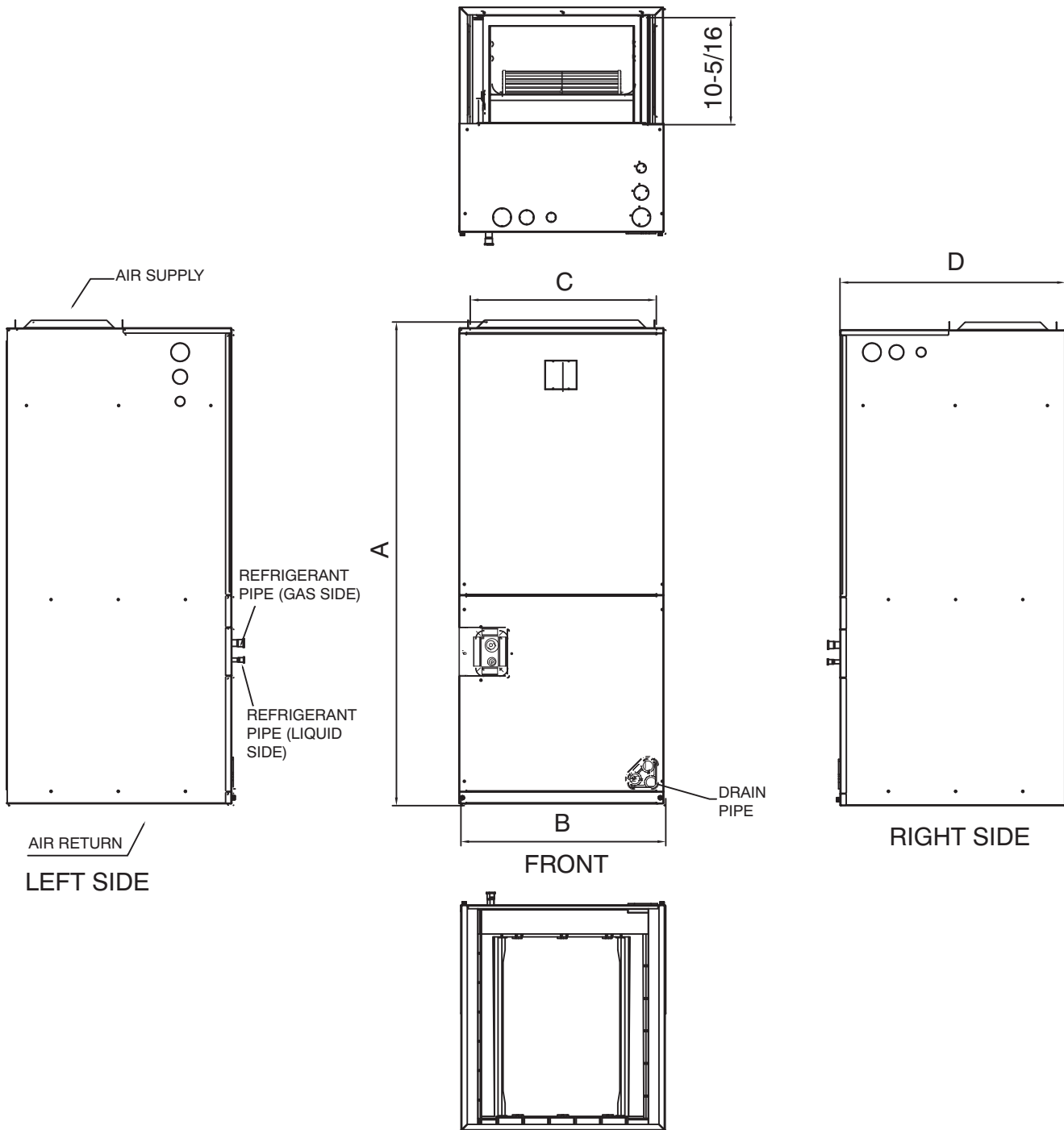

40VMV UNIT SIZE	A	B	C	D
012A-030A	$46\text{-}1/2$	$19\text{-}5/8$	18	$21\text{-}5/8$
036A-054A	$54\text{-}1/2$	22	$19\text{-}1/2$	24

**NOTE:** All dimensions shown in inches.

**Fig. 2 —40VMV012A-054A Dimensions**

## INSTALLATION

**Step 1 — Unpack and Inspect Units** Units are packaged for shipment to avoid damage during normal transit and handling. It is the receiving party's responsibility to inspect the equipment upon arrival. Any obvious damage to the carton and/or its contents should be reported on the bill of lading and a claim should be filed with the transportation company and the factory. Unit should always be stored in a dry place, and in the proper orientation as marked on the carton.

### ⚠ CAUTION

To avoid equipment damage, do not lift unit by the drain pipe or refrigerant piping. Unit should be lifted using the mounting brackets.

After determining the condition of the carton exterior, carefully remove each unit from the carton and inspect for hidden damage. Check to make sure that items such as thermostats and controllers are accounted for whether packaged separately or shipped at a later date. Any hidden damage should be recorded, a claim should be filed with the transportation company, and the factory should be notified. If a claim for shipping damage is filed, the unit, shipping carton, and all packing must be retained for physical inspection by the transportation company. All units should be stored in the factory shipping carton with internal packaging in place until installation.

**PROTECTING UNITS FROM DAMAGE** Do not apply force or pressure to the coil, piping, or drain stub-outs during handling. All units should be handled by the chassis or as close as possible to the unit mounting point locations.

The unit must always be properly supported. Temporary supports used during installation or service must be adequate to hold the unit securely. To maintain warranty, protect units against hostile environments (such as rain, snow or extreme temperature), theft, vandalism, and debris on jobsite. Equipment covered in this manual is not suitable for outdoor installations. Do not allow foreign material to fall into drain pan. Prevent dust and debris from being deposited on motor, fan wheels, and coils. Failure to do so may have serious adverse effects on unit operation, and in the case of motor and blower assembly, may result in immediate or premature failure. Failure of any unit caused by deposits of foreign material on the motor or blower wheels will not be covered by the manufacturer's warranty. Some units and/or job conditions may require some form of temporary covering during construction.

**PREPARING JOBSITE FOR UNIT INSTALLATION** To save time and to reduce the possibility of costly errors, set up a complete sample installation in a typical room at jobsite. Check all critical dimensions such as pipe, wire, and duct connections requirements. Refer to job drawings and product dimension drawings as required. Instruct all trades in their parts of the installation. Units must be installed in compliance with all applicable local code requirements.

**IDENTIFYING AND PREPARING UNITS** Be sure power requirements match available power source. Refer to unit nameplate and wiring diagram. In addition:

- Check all tags on unit to determine if shipping screws are to be removed. Remove screws as directed.
- Rotate the fan wheel by hand to ensure that the fan is unrestricted and can rotate freely. Check for shipping damage and fan obstructions. Adjust blower motor as required.
- The condensate drain should have sufficient downward slope (1 inch per 100 inches) in any horizontal run between unit and drain

## Step 2 — Position the Unit

### ⚠ DANGER

Units must not be installed where they may be exposed to potentially explosive or flammable atmosphere. If this instruction is not followed exactly, a fire or explosion may result, causing property damage, injury, or loss of life.

Install the unit in a location that meets the following requirements:

- Allow adequate space for installation, service clearance, piping and electrical connections, and necessary ductwork. For specific unit dimensions, refer to Table 2, Fig. 2, and Fig. 3. Allow clearance according to local and national codes.
- Unit can be installed standing vertically on the floor or on a field-provided stand. If a stand is used, be sure it can support the weight of the unit. Unit can also be installed horizontally, either resting on the floor or suspended from the ceiling. If suspended, confirm that the ceiling is able to support the weight of the unit. See Table 2 for nominal weight.
- If the unit is to be installed over a finished ceiling and/or living area, building codes may require a field-supplied secondary condensate drain pan to be installed under the entire unit. Consult local codes inspector for additional information.

Select the unit position with the following points in mind:

- The unit should be installed on a structure that is suitable to support the total weight of the unit, refrigerant piping, and condensate.
- Proper access should be provided for maintenance for refrigerant piping, EEV (electronic expansion valve), electrical box, and condensate pump. A 2-ft. clearance is recommended all around the unit.
- The unit should not be positioned close to a wall or similar obstruction or in a position where the discharge air could blow directly on the thermostat. See Fig. 3.
- The unit should not be positioned directly above any obstruction.
- The unit must be installed square and level.

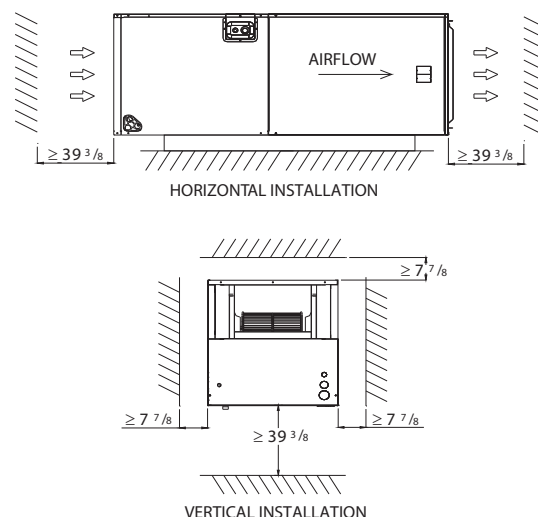

**NOTE:** All dimensions shown in inches.

**Fig. 3 —Clearances**

**IMPORTANT:** If the unit is installed in the ceiling, be sure that the ceiling grid is supported separately from the unit. The ceiling grid must not be supported by any part of the unit, grille, or any associated wiring or piping work.

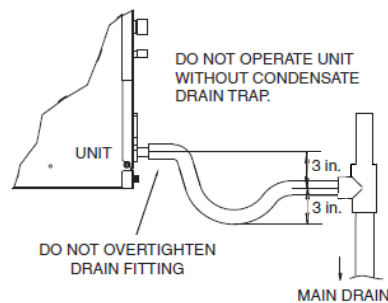

**Fig. 4 —Condensate Drain Trap**

### Step 3 — Install Ductwork

**UPFLOW INSTALLATION** If return air is to be ducted, install duct flush to the floor. Only use the return-air opening provided. All return air must pass through the coil.

**HORIZONTAL INSTALLATIONS** Be sure installation complies with all applicable building codes, which may require installation of a secondary condensate pan.

**NOTE:** To ensure proper drainage for horizontal installations, unit must be installed so it is within 1/8-in. pitch of the length and width of the unit.

1. Arrange support for unit by setting it in or above secondary condensate pan.
2. When suspending unit from ceiling, dimples in casing indicate proper location of screws for mounting metal support straps.

**DUCT CONNECTIONS** Connect supply-air duct over outside of 3/4-in. flange provided on supply-air opening. Secure duct to flange with proper fasteners for type of duct used, and seal duct-to-unit joint.

Duct connection flanges are provided at the discharge air unit connection.

Use flexible connectors between ductwork and unit to prevent transmission of vibration. Ductwork passing through unconditioned space must be insulated and covered with vapor barrier.

**DUCTWORK ACOUSTICAL TREATMENT** Metal duct systems that do not have a 90° elbow and 10 feet of main duct to first branch takeoff may require internal acoustical insulation lining.

As an alternative, fibrous ductwork may be used if constructed and installed in accordance with the latest edition of SMACNA (Sheet Metal and Air-Conditioning Contractors' National Association) construction standard on fibrous glass ducts. Both acoustical lining and fibrous ductwork shall comply with National Fire Protection Association Standards 90A or B as tested by UL (Underwriters Laboratories) Standard 181 for Class 1 air ducts.

### Step 4 — Connect Piping

**CONDENSATE PIPING** The unit is supplied with a 3/4-in. female pipe thread drain connection to connect drain piping. When installing the unit, follow these recommendations:

- Condensate piping should slope downward in the direction of condensate flow, with a minimum gradient of 1 inch per 100 inches.
- Condensate piping should be installed in such a way that it does not block the front service panel.
- A drain trap may be required by local codes and is recommended for odor control.
- The differential height between inlet and outlet should be at least three inches. The differential height between the bottom of the trap and outlet should also be three inches. See Fig. 4.

- Auxiliary drain should be connected and run to a location where it is easily visible when it becomes active suggesting a problem with the main drain system.
- When multiple units are connected to a common condensate drain, ensure that the drain is large enough to cope with the volume of condensate from all units. It is also recommended to have an air vent in the condensate piping to prevent air locks.
- Insulate the drain line to prevent sweating and provide proper support to prevent undue stress.
- Condensate piping must not be installed where it may be exposed to freezing temperatures.

### REFRIGERANT PIPING

#### ⚠ CAUTION

When connecting from an indoor unit to an outdoor unit, the isolation valve at the outdoor unit should be in the closed position throughout the refrigerant piping process. Failure to follow this procedure may result in equipment damage.

When connecting from an indoor unit to an outdoor unit, follow these procedures:

- Check for maximum height drop and length of refrigerant piping between the indoor and outdoor unit. If the difference is more than 33 feet, consider mounting the outdoor unit above indoor unit.
- Refrigerant piping connection between indoor and outdoor units should be performed once the units are secured at their respective installation locations.
- The refrigeration piping starts at the indoor unit and ends at the outdoor unit.
- There must be less than 15 bends in the refrigeration piping.
- The refrigerant piping should be dry and free of dust and other contaminants.
- The bending angle of the refrigerant pipe should not exceed 90° and the bending radius should be as large as possible to prevent any breakage in piping.
- Use a torque wrench for flare nuts. Refer to Table 3 for flare nut torque recommendations.
- Use proper cutting and flaring tools to avoid leakage.

**Table 3 —Flare Nut Torque Recommendations**

Outside Diameter (in.)	Recommended Torque (ft-lb)
1/4	15
3/8	26
1/2	41
5/8	48

- Before insulating the suction and liquid refrigeration pipes, perform pressure and leak tests. For details, see the outdoor unit installation manual. Insulating both suction and liquid refrigerant pipes is required.
- Vacuuming and charging of the system should be carried out as described in the outdoor unit installation manual.

## Step 5 — Complete Electrical Connections

Installation of wiring must conform with local building codes, or in the absence of local codes, with National Electric Code ANSI/NFPA 70, current editions. Units must be electrically grounded in conformance with the code. In Canada, wiring must comply with CSA C22.1, Electrical Code.

### ⚠ WARNING

Electrical shock can cause personal injury and death. Disconnect power supply before making wiring connections. There may be more than one disconnect switch. Tag all disconnect locations to alert others not to restore power until work is completed.

### ⚠ WARNING

All units must be wired strictly in accordance with the wiring diagram furnished with the unit. Any wiring different from the wiring diagram could result in personal injury and property damage.

### ⚠ CAUTION

Any original factory wiring that requires replacement must be replaced with wiring material having a temperature rating of at least 221°F.

Ensure supply voltage to the unit, as indicated on the serial plate, is not more than 10% over the rated voltage or 10% under the rated voltage.

Failure to follow these recommendations may result in equipment damage.

This equipment in its standard form is designed for an electrical supply of 208/230-1-60. Any damage to or failure of units caused by incorrect wiring or voltage is not covered by warranty.

Electric wiring must be sized to carry the full load amp draw of the motor, starter, and any other controls that are used with the unit. See Table 4 for electrical data.

Table 4 — 40VMV Electrical Data

40VMV UNIT SIZE	POWER SUPPLY	
	MCA	MOPD
012A	1.5	15
018A	3.8	15
024A	3.8	15
030A	3.8	15
036A	5.3	15
048A	5.3	15
054A	7.2	15

#### LEGEND

MCA — Minimum Circuit Amps  
MOPD — Maximum Overcurrent Protective Device



After the pipe work is complete, the electrical supply can be connected by routing the cable through the appropriate casing holes or knockouts and connecting the supply and ground cables to the unit's power terminal.

Be sure the power wiring and control wiring do not cross, as this might cause disturbance on the controls side. See Fig. 5 for wiring diagram.

**NOTE:** The indoor unit requires its own power supply. Indoor units are not powered from outdoor units.

## Step 6 — Position and Connect Controller

**NOTE:** Controllers are ordered separately.

Wired controllers should be installed in a position that maintains good temperature control:

- Position the thermostat approximately 48 inches above floor level.
- Do not position thermostat where it can be directly affected by the unit's discharge airstream.
- Avoid external walls and drafts from window and doors.
- Avoid positioning near shelves and curtains as these restrict air movement.
- Avoid heat sources such as direct sunlight, heaters, dimmer switches, and other electrical devices.

See Fig. 6 and Fig. 7.

## CONTROL WIRING

1. The communication wire should be 2-core stranded shielded cable.
2. For indoor and outdoor unit communication, use P, Q terminals. Shielded core should be used for ground.
3. Wiring should be done according to wiring diagram.
4. Communication wire must not form a closed loop.
5. Use separate conduit for power and control wiring.

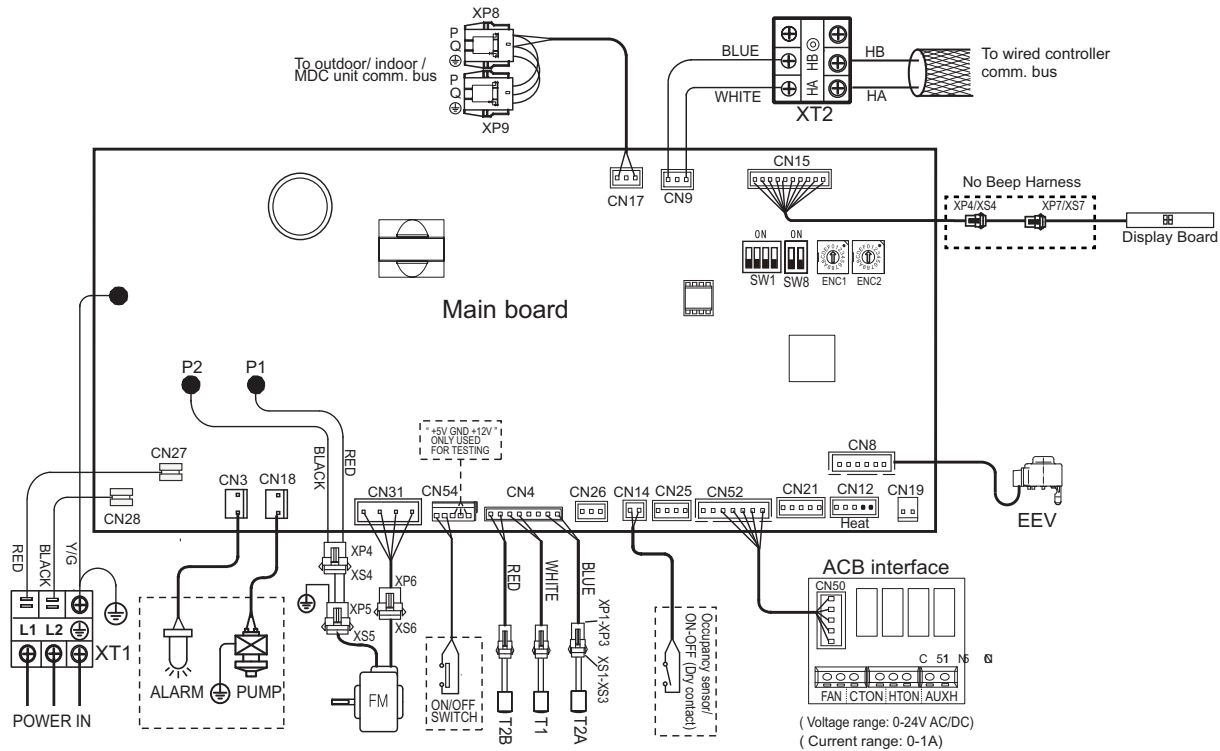

- LEGEND**
- ALARM — Warning lamp (optional)
  - AUXH — Output for Auxiliary Heat
  - CTON — Output for Cooling Operation
  - EEV — Electronic Expansion Valve
  - FAN — Output for Fan Operation
  - FM — Indoor Fan Motor
  - HTON — Output for Heating Operation
  - MDC — Multiport Distribution Controller
  - PUMP — Pump Motor
  - T1 — Room Temperature Sensor
  - T2A — Inlet Pipe Temperature Sensor
  - T2B — Evap. Outlet Temperature in Cooling Mode
  - XP1-9 — Connectors
  - XS1-7 — Connectors
  - XT1-2 — Terminal Block

**Fig. 5 —40VMV012A-054A Typical Wiring Diagram**

**OPTION/EXTENSIONS OF COMMUNICATION WIRING**

To extend control wiring or make terminal connections, use the PQ connection wire supplied in the accessory kit and follow the steps below.

1. Cut the connector on the outdoor unit side as shown in Fig. 7.

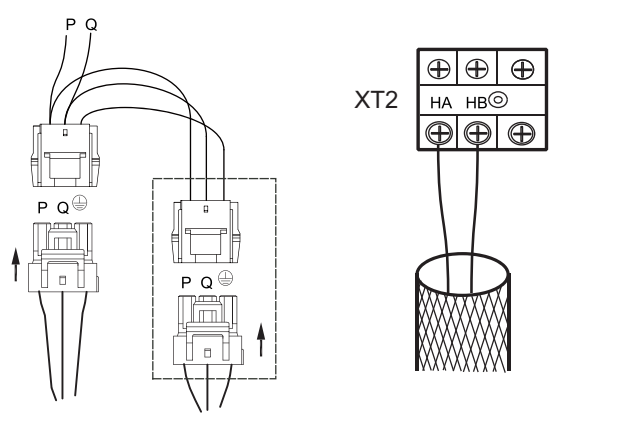

To outdoor/indoor/MDC units comm. bus      To wired controller comm. bus

**Fig. 6 —Communication Wire Connection**

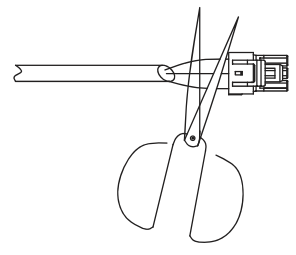

**Fig. 7 —Shearing Outdoor Connector**



- Strip a suitable length of the insulation layer as shown in Fig. 8.

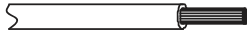

**Fig. 8 — Stripping the Wire**

- Use a suitable screwdriver to fix communication wire on outdoor unit communication terminal as shown in Fig. 9.

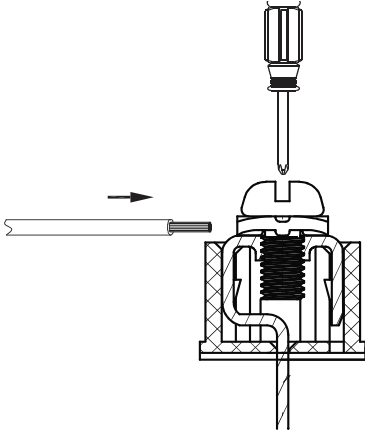

**Fig. 9 — Connecting Communication Wire to Outdoor Unit Communication Terminal**

**IMPORTANT:** Wiring for communication shall be two inches or more apart from power source wiring to avoid electric noise. Do not insert control/communication and power source wire in the same conduit. Pay attention to the polarity of the communication wire.

If communication wires are use to connect between indoor units, find the corresponding port and plug it in directly as shown in Fig. 10.

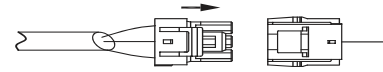

**Fig. 10 —Connecting the Communication Wires**

If it is not possible to buy communication wires from Carrier, connect the indoor unit side of the communication wires using the connector provided with the accessories as shown in Fig. 11-13.

**CAUTION**

Failure to follow these procedures may result in personal injury or damage to equipment.

NEVER CONNECT the main power source to the control or communication terminal block.

USE AN APPROPRIATE SCREWDRIVER for tightening the terminal screws. Do not over tighten the terminal screws.

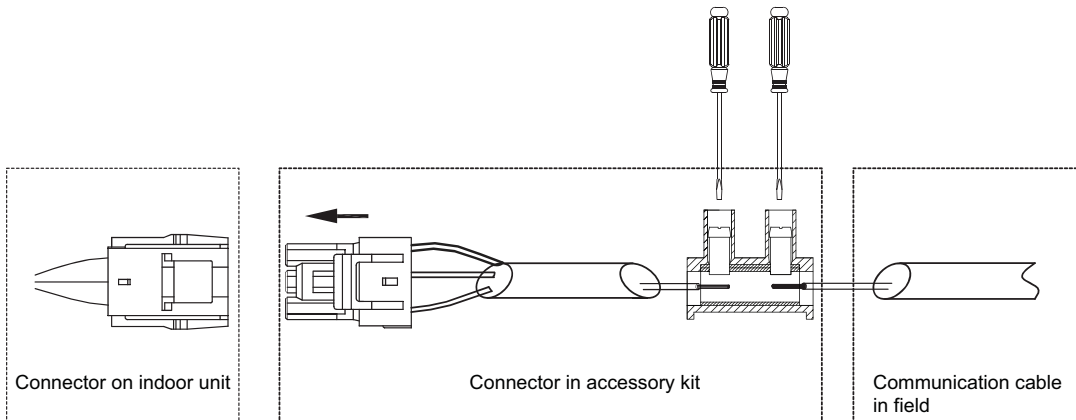

**Fig. 11 — Connecting the Communication Cable to Indoor Unit to Outdoor Unit Using the Supplied Connector**

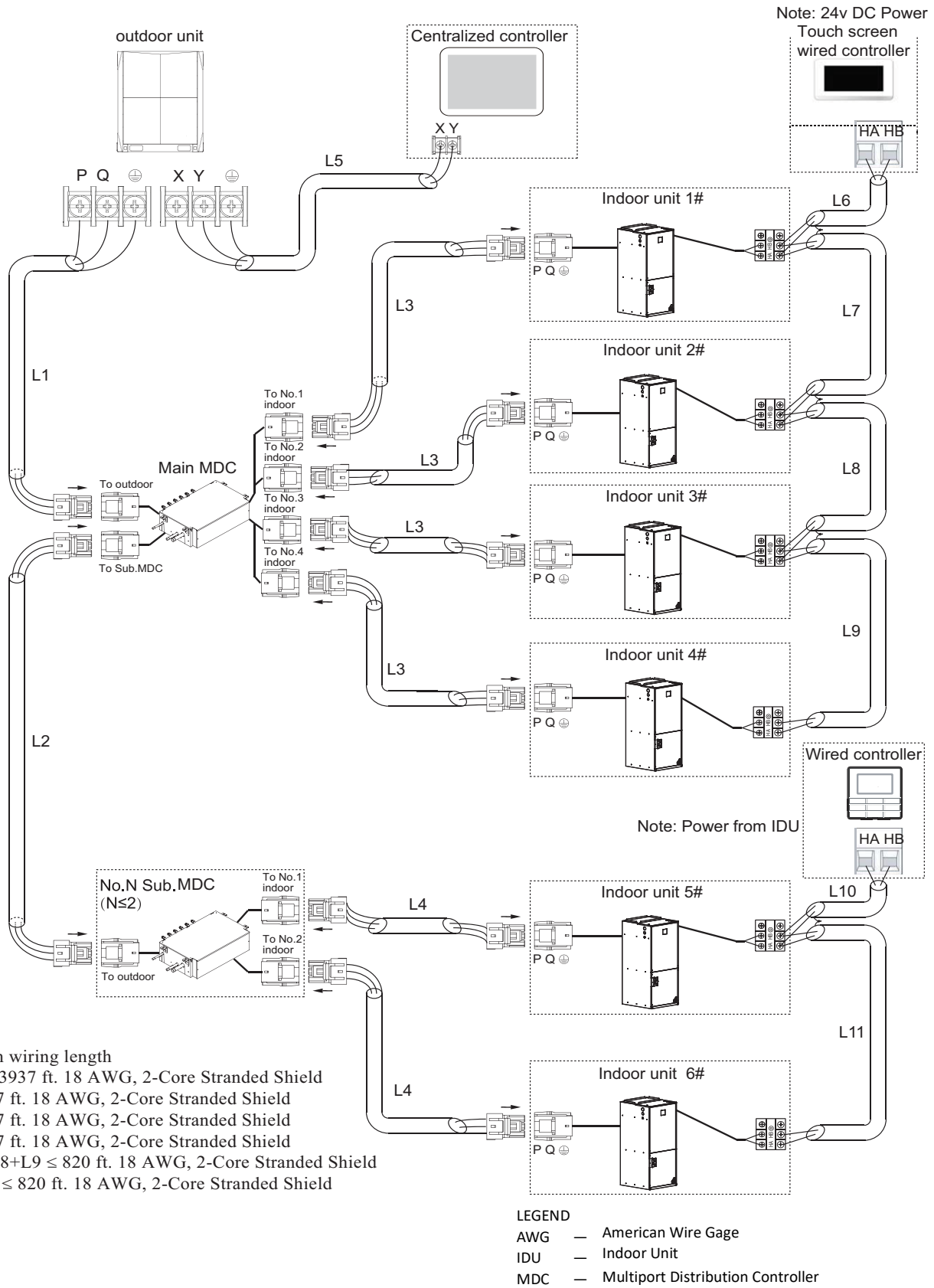
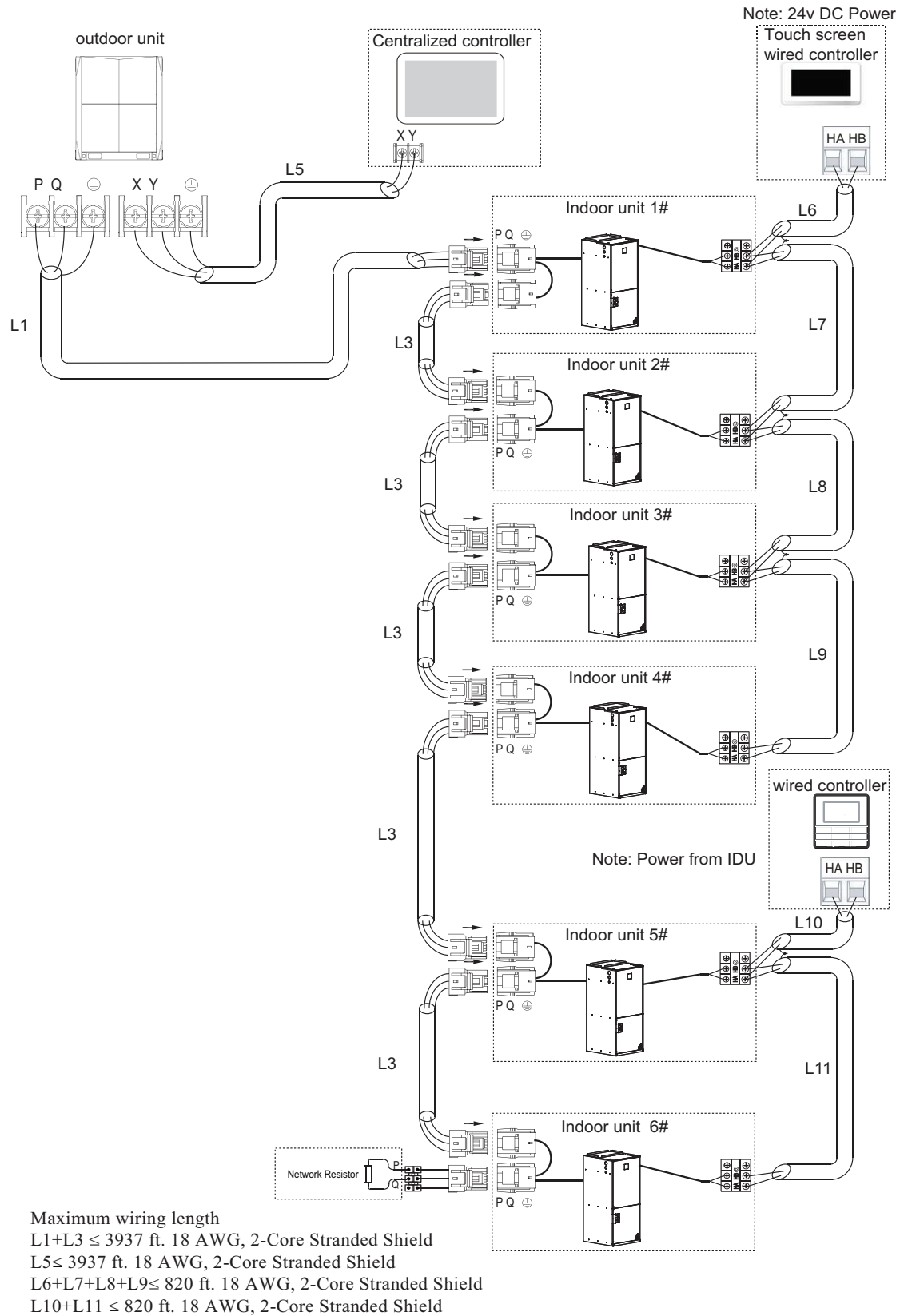
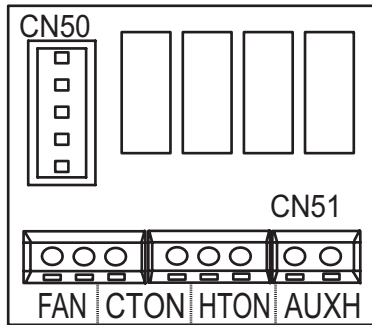

Fig. 12 — Typical Communication Wiring of Heat Recovery System



**Fig. 13 — Typical Communication Wiring of Heat Pump System**

**ACB (Auxiliary Control Board) Interface** — The ACB interface is a dry contact board that can output up to four signals controlling devices. Refer to Fig. 14 for connecting devices to the ACB interface board.



MAX AMPS	1A
MAX VOLTAGE	24V

**LEGEND**

- ACB — Auxiliary control board
- AUXH — Output for auxiliary heat
- CTON — Output for cooling operation
- FAN — Output for exhaust fan
- HTON — Output for heating operation

**Fig. 14 —ACB Interface**

**START-UP**

**Pre-Start Check** Once installation is complete, make the following pre-start checks:

1. All indoor and outdoor units are properly installed.
2. All piping and insulation is complete.
3. All electrical connections (both power and control) are properly terminated.
4. All condensate drains are installed correctly.
5. The power supply is of the right voltage and frequency.
6. The units are properly grounded in accordance with current electrical codes.
7. Suction and liquid line service valves are in open position.

**System Operation Check** Once the installation and pre-start checks are completed, follow these steps:

1. Using remote controller, select cooling or heating mode to check the operation of the system.
2. While the system is in operation, check the following on indoor unit:
  - a. Switches or buttons on the remote controller are easy to push.
  - b. Indicator light is showing normal operation and no error is indicated.
  - c. Swing mode of air louvers is working (if applicable to unit).
  - d. Drain pump operation is normal (if applicable).
  - e. No abnormal vibration or noise is noticed.

3. While the system is in operation, check the following on outdoor unit:
  - a. No abnormal vibration or noise is noticed.
  - b. Condenser fan is in operation.
  - c. Indicator light is showing normal operation and no error is indicated.

**NOTE:** If the unit is turned off or restarted, there is a time delay of three minutes for the compressor to start from the time the power is restored.

**MAINTENANCE**

**⚠ CAUTION**

When servicing or repairing this unit, use only factory-approved service replacement parts. Refer to the rating plate on the unit for complete unit model number, serial number and company address. Any substitution of parts or controls not approved by the factory will be at the owner's risk and may result in equipment damage.

**⚠ CAUTION**

To avoid equipment damage, do not attempt to reuse any mechanical or electrical controllers that have been wet. Replace defective controller.

**Every 3 Months:**

- Check the air filter condition. Clean or replace if necessary.

**Every 6 Months:**

Follow 3-month maintenance schedule. In addition:

- Clean condensate tray with suitable cleaning agent.
- Clean the grille and panel.

**Every 12 Months:**

Follow 6-month maintenance schedule. In addition:

- Be sure all electrical connections are secure.
- Check condensate pump operation.
- Check the heating and cooling action to confirm proper operation.

**INDOOR UNIT ADDRESSING**

For proper system operation, each indoor unit must have a unique address set from 0 to 63. When setting an address by remote controller; the outdoor units, indoor units, and MDC must be powered on. If FE is displayed on the LED screen or display board, this unit has no address. After setting all indoor units' addresses, turn off the power supply to all indoor units to clear errors.

Indoor units' addressing can be distributed automatically in the heat pump system. When dip switch "S6" on the outdoor unit's main PCB board is set to 00 (default set in factory), indoor units are set for auto-addressing. When powering on for the first time, it takes six minutes or more to finish auto-addressing each indoor unit. The heat recovery system cannot accomplish this function at this time.

**Wireless Remote Controller (40VM900001)**

Indoor unit addressing can be performed using the wireless remote controller. When using the wireless controller, the user must maintain a line of sight with the receiver on the indoor unit. See Fig. 15 for a description of the buttons on the wireless remote.

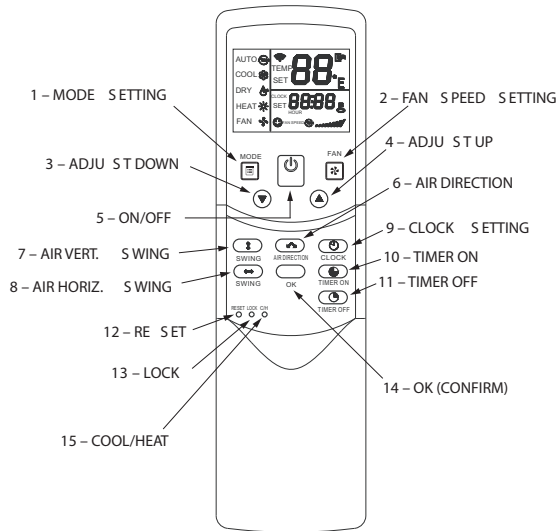

**Fig. 15 —Wireless Remote Controller (40VM900001)**

Use a tool to press and hold the LOCK button for at least ten seconds. Press to activate. Click or to select an address and press to send the setting.

To display an indoor unit address, use a tool to press and hold the LOCK button for at least ten seconds, and press to query the addresses.

**Non-Programmable Controller**

When setting an address, connect only one wired controller to an indoor unit.

Press **ROOM TEMP** and **SWING** simultaneously for three seconds. If there is no address for this indoor unit, the display shows **FE# 00** as shown in Fig. 16. Otherwise, the display shows the current address of the indoor unit.

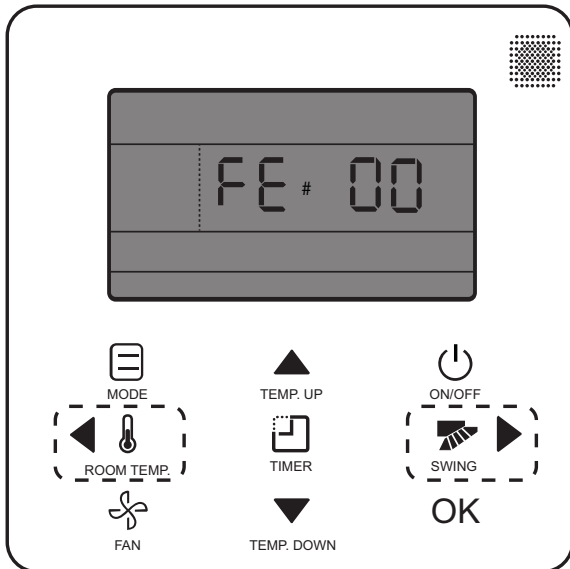

**Fig. 16 — Non-Programmable Controller IDU Addressing Menu**

Click **TEMP. UP** or **TEMP. DOWN** to change 00 to the desired address as shown in Fig. 17. Press **OK** to confirm and exit the setting interface.

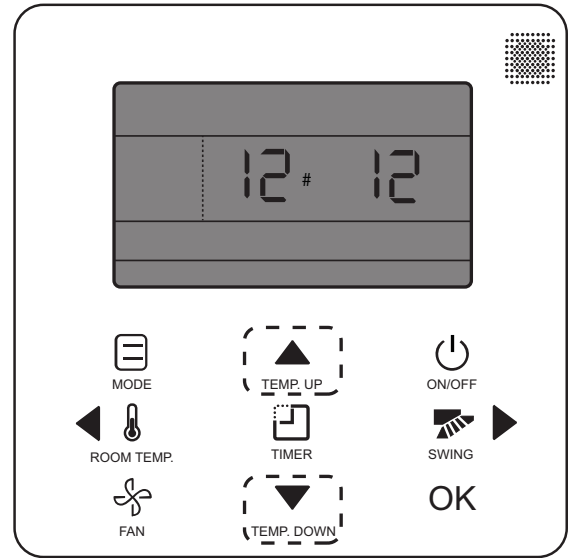
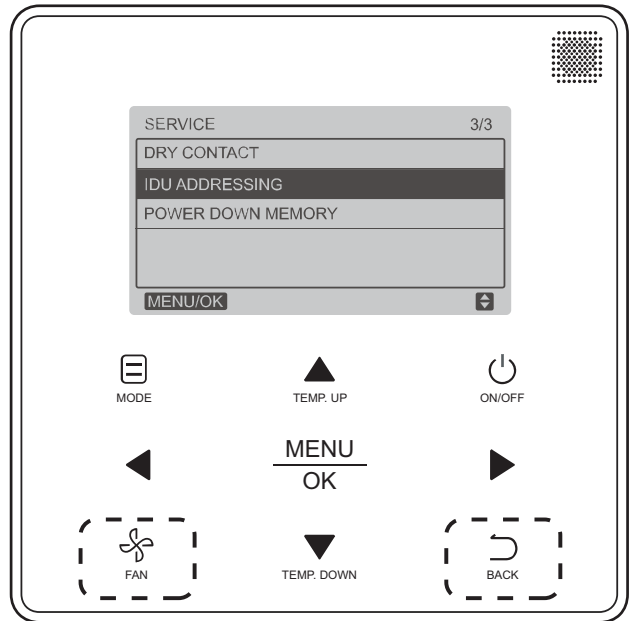

**Fig. 17 — Non-Programmable Controller Setting IDU Address**

**Programmable Controller**

When setting an address, connect only one wired controller to an indoor unit.

1. Access parameter settings as shown in Fig. 18.



**Fig. 18 —Programmable Controller IDU Addressing Menu**

2. Press **TEMP. UP** or **TEMP. DOWN** to move the cursor down and choose **IDU ADDRESSING**, and select **MENU/OK** to access this setting.

3. Press **TEMP. UP** or **TEMP. DOWN** to choose the address you want to set as shown in Fig. 19. Press **MENU/OK** to send this address to the IDU.

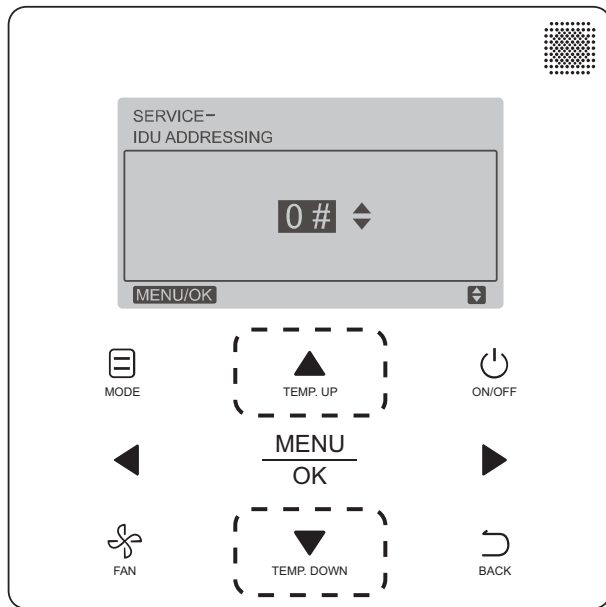
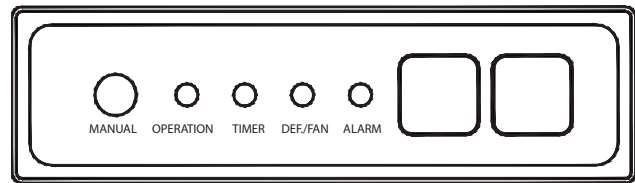

**Fig. 19 —Programmable Controller Setting IDU Address**

4. Press **BACK** twice or wait 30 seconds to automatically exit the parameter settings menu.

## TROUBLESHOOTING

Fig. 20 shows the LED display panel. See Table 5 for a summary of display indicators. Table 6 lists problems, possible causes, and possible solutions.



**Fig. 20 —Display Panel**

**Table 5 — Display Indicators**

ERROR CODE		MODE / STATUS
[NO ERROR]	Setting Temperature	Starting
	"--"	Shutdown
	"--"	Standby
	"--"	Timing ON
	"--"	Timing OFF
	Setting Temperature	System Defrost ON
	Setting Temperature	System Defrost OFF
ERROR	dd	Heating / Cooling Mode Conflict Error
	E1	Communication Error Between Indoor and Outdoor Unit
	E2	Check Indoor Ambient Temperature Sensor (T1)
	E4	Check Evaporator Temperature Sensor (T2)
	E5	Check Evaporator Outlet Temperature Sensor (T2B)
	E6	Check DC Fan Motor
	E7	EEPROM Error (Data Storage)
	E9	Communication Error Between Indoor Unit & Controller
	Eb	EEV Error
	Ed	Outdoor Unit Error
	EE	Condensate Error
	FE	No Address When Power ON For First Time
	UU	MDC Error In Auto System-Check Mode

LEGEND  
 EEPROM — Electronically Erasable Programmable Read-only Memory  
 EEV — Electronic Expansion Valve  
 MDC — Multiport Distribution Controller

**Table 6 —Troubleshooting**

ERROR	DESCRIPTION	POSSIBLE CAUSES	POSSIBLE SOLUTIONS
dd	Heating / Cooling Mode Conflict	System is in cooling or fan only mode and heating signal is received from a unit on the system.	All units should be in cooling mode for system to stay in cooling mode.
		System is in heating mode and cooling signal is received from a unit in the system.	All units should be in heating mode.
E1	Communication Error Between Indoor & Outdoor Unit	Signal wires are short-circuited or disconnected.	Check or reconnect signal wire.
		Signal wire close to electromagnetic source.	Distance signal wires from electromagnetic source.
		PC board fault.	Replace PC board.
E2, E4, E5	Check Temperature Sensor	Loose connection at port on PC board.	Tighten the connection at port on PC board.
		Sensor is short-circuited.	Using multi-meter, measure resistance of the sensor. If the resistance is £ 100 ohms, change the sensor.
		PC board fault.	Replace PC board.
E6	DC Fan Motor	Operating Beyond Limits.	Check and correct external static pressure on the unit.
		DC motor fault.	Replace DC motor.
		PC board fault.	Replace PC board.
E7	EEPROM Error (Data Storage)	Chip or PC board fault.	Replace PC board.
E9	Communication Error Between Indoor Unit & Controller	Signal wires are short-circuited or disconnected.	Check or reconnect signal wires.
		Signal wires close to electromagnetic source.	Distance signal wires from electromagnetic source.
		PC board fault.	Replace PC board.
Eb	EEV Error	EEV wires are short-circuited or disconnected.	Replace EEV wires.
		EEV stop.	Replace EEV.
		PC Board fault.	Replace PC board.
Ed	Outdoor Unit Error	Outdoor unit fault.	Refer to outdoor unit troubleshooting guide.
EE	Condensate Error	Loose connection or disconnected.	Tighten the connection or reconnect at port on PC board.
		Water level float is stuck.	Inspect the slope.
		Trap slope is too steep.	Adjust the trap slope.
		Drain pipe is too long.	Adjust the length of drain pipe.
FE	No Address when Power ON for First Time	Drain pump faulty.	Replace the drain pump.
		Indoor unit without address.	Run automatic addressing option at the outdoor unit. Use remote wireless or wired controller to readdress indoor unit.
UU	MDC Auto System-Check Mode	MDC fault	Refer to MDC troubleshooting guide.

**LEGEND**

- EEPROM — Electronically Erasable Programmable Read-only Memory
- EEV — Electronic Expansion Valve
- MDC — Multiport Distribution Controller
- PC — Process Controller

## APPENDIX A —DIP SWITCH SETTINGS

There are two DIP switches on the main board. Figures A and B show the settings for each parameter controlled by a switch. Switches are shown in the default settings.



**POSITION 1 — START-UP**  
**OFF** — Auto Addressing Mode (Default)  
**ON** — Factory Test Mode



**POSITION 2 —**  
**OFF** — Normal Mode (Default)  
**ON** — Factory Self-Checking Mode



**POSITION 3 — NOT USED**

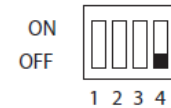

**POSITION 4 — INDOOR UNIT IDENTIFICATION**  
**OFF** — STANDARD INDOOR UNIT (Default)  
 — MODE PRIORITY INDOOR UNIT (HP ONLY)  
**ON** — (IDU address must be 63)

**Fig. A — SW1 Settings**





**OFF** — Thermal Off Fan Off (Default)  
**ON** — Thermal Off Fan On  
 (The wired controller must be connected to the indoor unit, and use the room temperature sensor on the wired controller to turn on this function)

**Fig. B — SW8 Settings**





**APPENDIX B —NAMEPLATES**



**Replacement Parts** — Quote the unit model number and unit serial number when ordering replacement parts or contacting the factory about the unit. This information can be found on the serial plates attached to the unit as shown in Figs. 21-27.

CONFORMS TO UL STD 1995 CERTIFIED TO CSA STD. C22. 2 No. 236						
ELECTRIC CHARACTERISTICS ARE ONLY FOR INDOOR UNIT.						
<b>Vertical Air Handler</b>						
MODEL	40VMV012---3					
POWER SUPPLY	208/230V-1Ph-60Hz					
MINIMUM CIRCUIT AMPACITY	1.5 A					
MAX FUSE OR HACR BREAKER	15 A					
MAX EXTERNAL STATIC PRESSURE	0.8 IN.W.C.					
FAN MOTOR	FLA	1.2 A				
	OUTPUT	100W				
REFRIGERANT	R410A					
DESIGN PRESSURE	HIGH	580 PSIG				
	LOW	320 PSIG				
Installed	Heater Kit Model	Electric Heat (KW)	Min. Circuit Ampacity	Max. Fuse or Breaker (HACR) Ampacity		
			240	208	240	208
<input type="checkbox"/>	40WA910005	5	29.8	26.8	30	30
<input type="checkbox"/>						
<input type="checkbox"/>						
SERIAL NO.		 1716V00001				
<i>Carrier Corporation</i>						



**Fig. 21 —40VMV012---3 Unit Serial Plate**

CONFORMS TO UL STD 1995 CERTIFIED TO CSA STD. C22. 2 No. 236						
ELECTRIC CHARACTERISTICS ARE ONLY FOR INDOOR UNIT.						
<b>Vertical Air Handler</b>						
MODEL	40VMV018---3					
POWER SUPPLY	208/230V-1Ph-60Hz					
MINIMUM CIRCUIT AMPACITY	3.8 A					
MAX FUSE OR HACR BREAKER	15 A					
FAN MOTOR	FLA	3.0 A				
	OUTPUT	370W (1/2HP)				
REFRIGERANT	R410A					
DESIGN PRESSURE	HIGH	580 PSIG				
	LOW	320 PSIG				
Installed	Heater Kit Model	Electric Heat (KW)	Min. Circuit Ampacity	Max. Fuse or Breaker (HACR) Ampacity		
			240	208	240	208
<input type="checkbox"/>	40WA910005	5	29.8	26.8	30	30
<input type="checkbox"/>						
<input type="checkbox"/>						
SERIAL NO.		 1716V00001				
<i>Carrier Corporation</i>						

**Fig. 22 —40VMV018---3 Unit Serial Plate**

CONFORMS TO UL STD 1995 CERTIFIED TO CSA STD. C22. 2 No. 236						
ELECTRIC CHARACTERISTICS ARE ONLY FOR INDOOR UNIT.						
<b>Vertical Air Handler</b>						
MODEL	40VMV024---3					
POWER SUPPLY	208/230V-1Ph-60Hz					
MINIMUM CIRCUIT AMPACITY	3.8 A					
MAX FUSE OR HACR BREAKER	15 A					
FAN MOTOR	FLA	3.0 A				
	OUTPUT	370W (1/2HP)				
REFRIGERANT	R410A					
DESIGN PRESSURE	HIGH	580 PSIG				
	LOW	320 PSIG				
Installed	Heater Kit Model	Electric Heat (KW)	Min. Circuit Ampacity	Max. Fuse or Breaker (HACR) Ampacity		
			240	208	240	208
<input type="checkbox"/>	40WA910005	5	29.8	26.8	30	30
<input type="checkbox"/>	40WA910007	7.5	42.8	37.8	45	40
<input type="checkbox"/>						
SERIAL NO.		 1716V00001				
<i>Carrier Corporation</i>						

**Fig. 23 —40VMV024---3 Unit Serial Plate**

CONFORMS TO UL STD 1995 CERTIFIED TO CSA STD. C22. 2 No. 236						
ELECTRIC CHARACTERISTICS ARE ONLY FOR INDOOR UNIT.						
<b>Vertical Air Handler</b>						
MODEL	40VMV030---3					
POWER SUPPLY	208/230V-1Ph-60Hz					
MINIMUM CIRCUIT AMPACITY	3.8 A					
MAX FUSE OR HACR BREAKER	15 A					
FAN MOTOR	FLA	3.0 A				
	OUTPUT	370W (1/2HP)				
REFRIGERANT	R410A					
DESIGN PRESSURE	HIGH	580 PSIG				
	LOW	320 PSIG				
Installed	Heater Kit Model	Electric Heat (KW)	Min. Circuit Ampacity	Max. Fuse or Breaker (HACR) Ampacity		
			240	208	240	208
<input type="checkbox"/>	40WA910005	5	29.8	26.8	30	30
<input type="checkbox"/>	40WA910007	7.5	42.8	37.8	45	40
<input type="checkbox"/>	40WA910010	10	55.8	48.8	60	50
SERIAL NO.		 1716V00001				
<i>Carrier Corporation</i>						

**Fig. 24 —40VMV030---3 Unit Serial Plate**



CONFORMS TO UL STD 1995 CERTIFIED TO CSA STD. C22. 2 No. 236						
ELECTRIC CHARACTERISTICS ARE ONLY FOR INDOOR UNIT.						
<b>Vertical Air Handler</b>						
MODEL		40VMV036---3				
POWER SUPPLY		208/230V-1Ph-60Hz				
MINIMUM CIRCUIT AMPACITY		5.3 A				
MAX FUSE OR HACR BREAKER		15 A				
FAN MOTOR	FLA	4.2 A				
	OUTPUT	560W (3/4HP)				
REFRIGERANT		R410A				
DESIGN PRESSURE	HIGH	580 PSIG				
	LOW	320 PSIG				
Installed	Heater Kit Model	Electric Heat (KW)	Min. Circuit Ampacity		Max. Fuse or Breaker (HACR) Ampacity	
			240	208	240	208
<input type="checkbox"/>	40WA910005	5	31.3	28.3	35	30
<input type="checkbox"/>	40WA910007	7.5	44.3	39.3	45	40
<input type="checkbox"/>	40WA910010	10	57.3	50.3	60	60
SERIAL NO.		 1716V00001				
Carrier Corporation						

Fig. 25 —40VMV036---3 Unit Serial Plate



CONFORMS TO UL STD 1995 CERTIFIED TO CSA STD. C22. 2 No. 236						
ELECTRIC CHARACTERISTICS ARE ONLY FOR INDOOR UNIT.						
<b>Vertical Air Handler</b>						
MODEL		40VMV054---3				
POWER SUPPLY		208/230V-1Ph-60Hz				
MINIMUM CIRCUIT AMPACITY		7.2 A				
MAX FUSE OR HACR BREAKER		15 A				
FAN MOTOR	FLA	5.7 A				
	OUTPUT	560W (3/4HP)				
REFRIGERANT		R410A				
DESIGN PRESSURE	HIGH	580 PSIG				
	LOW	320 PSIG				
Installed	Heater Kit Model	Electric Heat (KW)	Min. Circuit Ampacity		Max. Fuse or Breaker (HACR) Ampacity	
			240	208	240	208
<input type="checkbox"/>	40WA910005	5	33.2	29.7	35	30
<input type="checkbox"/>	40WA910007	7.5	46.2	41	50	45
<input type="checkbox"/>	40WA910010	10	59.3	52.3	60	60
<input type="checkbox"/>	40WA910015	15	85.3	74.9	90	80
<input type="checkbox"/>	40WA910020	20	111.3	97.5	125	100
SERIAL NO.		 1716V00001				
Carrier Corporation						

Fig. 27 —40VMV054---3 Unit Serial Plate



CONFORMS TO UL STD 1995 CERTIFIED TO CSA STD. C22. 2 No. 236						
ELECTRIC CHARACTERISTICS ARE ONLY FOR INDOOR UNIT.						
<b>Vertical Air Handler</b>						
MODEL		40VMV048---3				
POWER SUPPLY		208/230V-1Ph-60Hz				
MINIMUM CIRCUIT AMPACITY		5.3 A				
MAX FUSE OR HACR BREAKER		15 A				
FAN MOTOR	FLA	4.2 A				
	OUTPUT	560W (3/4HP)				
REFRIGERANT		R410A				
DESIGN PRESSURE	HIGH	580 PSIG				
	LOW	320 PSIG				
Installed	Heater Kit Model	Electric Heat (KW)	Min. Circuit Ampacity		Max. Fuse or Breaker (HACR) Ampacity	
			240	208	240	208
<input type="checkbox"/>	40WA910005	5	31.3	28.3	35	30
<input type="checkbox"/>	40WA910007	7.5	44.3	39.3	45	40
<input type="checkbox"/>	40WA910010	10	57.3	50.3	60	60
<input type="checkbox"/>	40WA910015	15	83.3	73.3	90	80
<input type="checkbox"/>	40WA910020	20	109.3	95.3	110	100
SERIAL NO.		 1716V00001				
Carrier Corporation						

Fig. 26 —40VMV048---3 Unit Serial Plate

**APPENDIX C — FAN CURVES**

The Vertical Air Handling Unit is equipped with a constant cfm motor that automatically adjusts the fan speed if the actual cfm is beyond +/- 10% of the setpoint cfm.

Figures A-G show fan characteristics at high-speed, medium-speed, and low-speed.

External static pressure on the vertical air handling unit cannot exceed 0.8 in. wg.

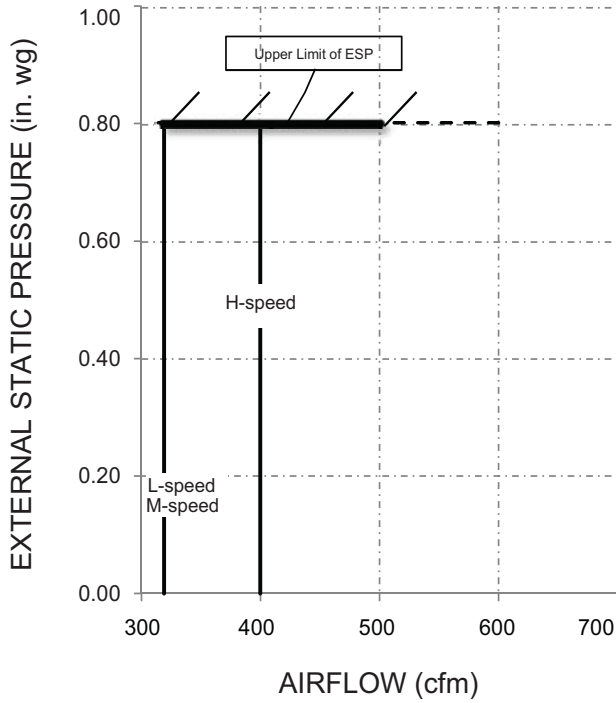

**Fig. A — 40VMV012A Fan Curves**

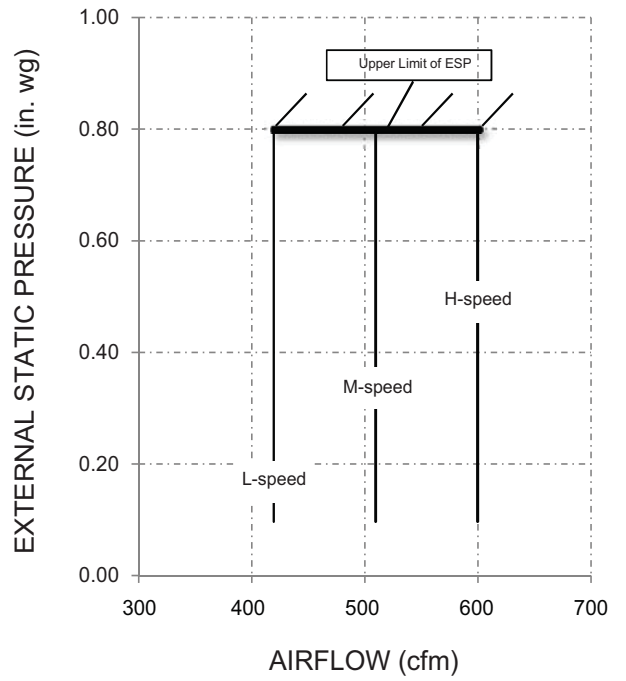

**Fig. C — 40VMV024A Fan Curves**

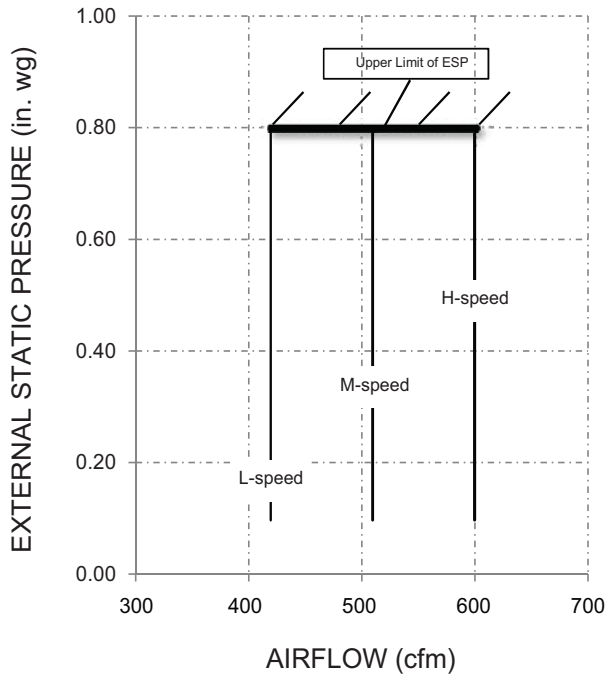

**Fig. B — 40VMV018A Fan Curves**

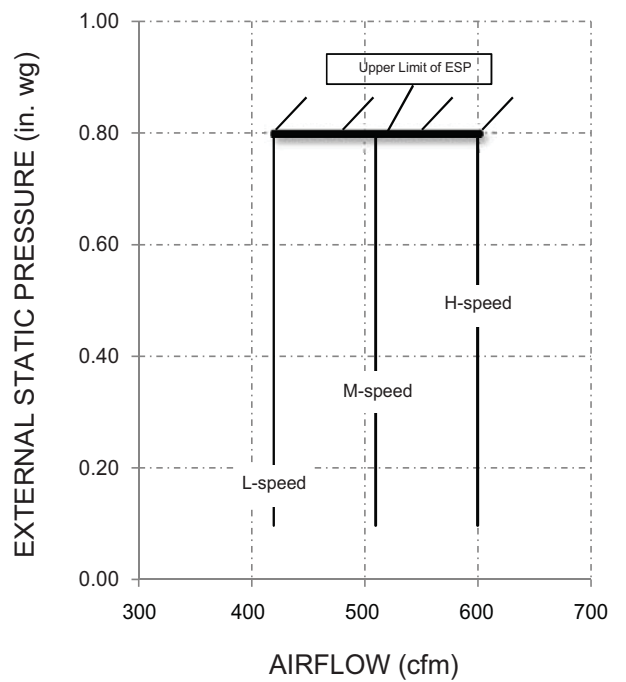

**Fig. D — 40VMV030A Fan Curves**

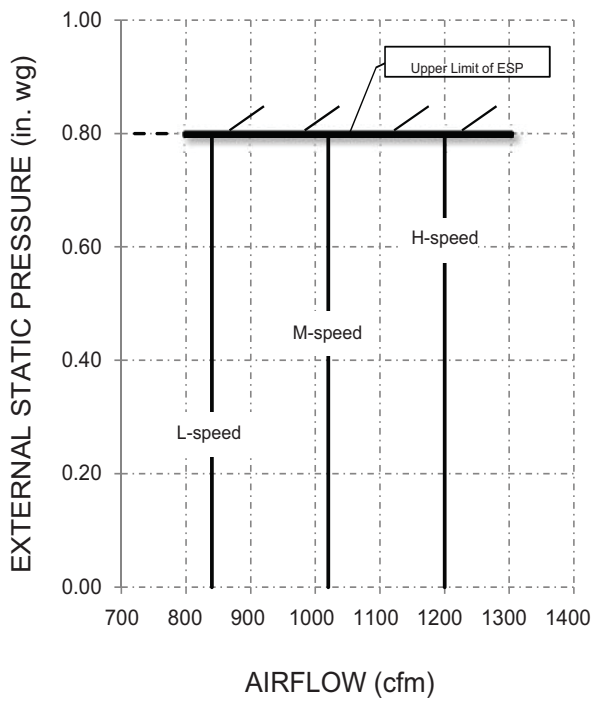

**Fig. E —40VMV036A Fan Curves**

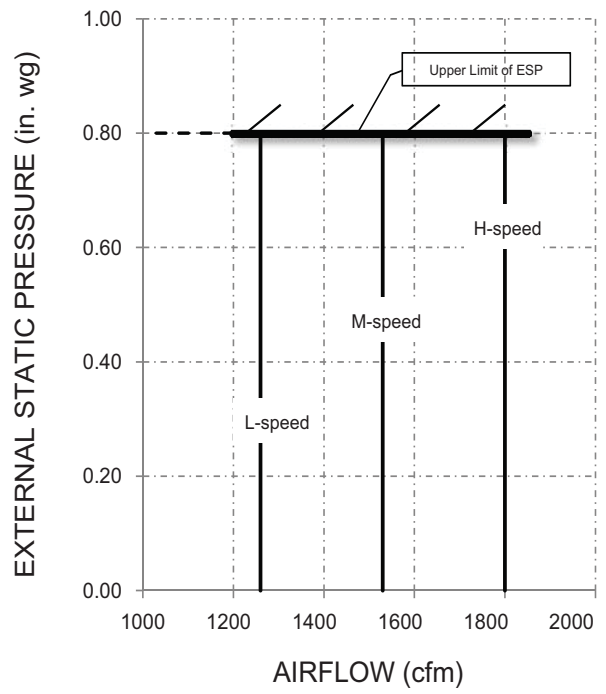

**Fig. G —40VMV054A Fan Curves**

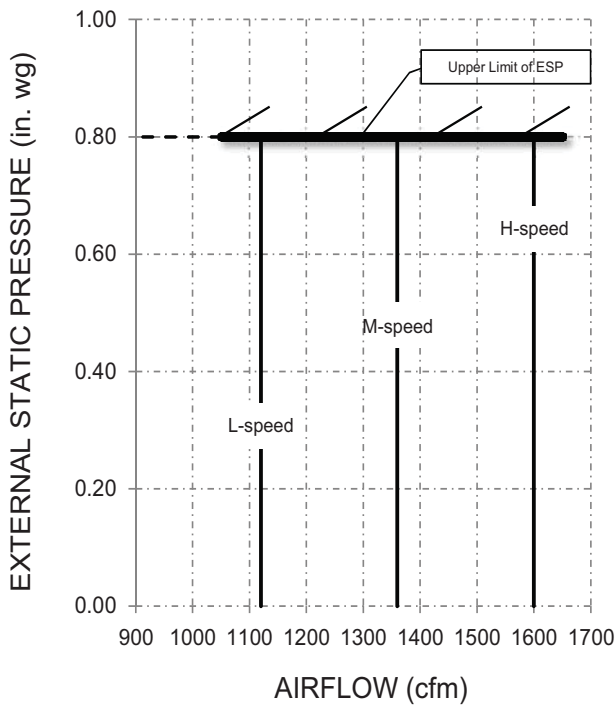

**Fig. F —40VMV048A Fan Curves**